

**SPECIFICATIONS**

Shell: ABS (UL94-HB)  
 Shell Plating: Nickel Plated  
 Accessories: Steel, Nickel Plating

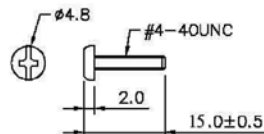
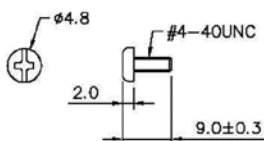
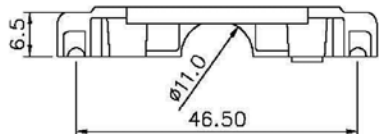
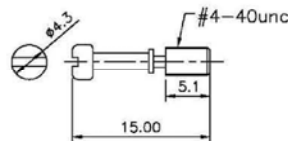
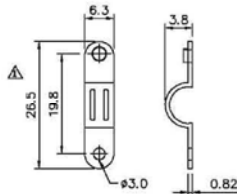
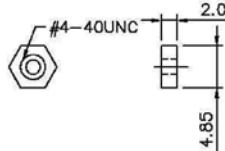
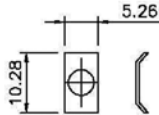
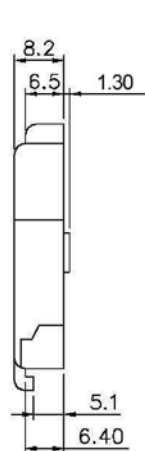
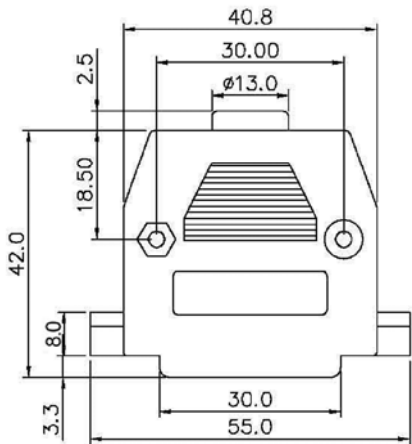

Series	Material	Hardware
DBS25	XX	XX
D-Sub Backshell	PG=Gray Plastic PB=Black Plastic PI=Ivory Plastic PN=Nickle Plated Plastic	SS=Standard Screw MS=Metal Thumb Screw

RoHS compliant

Rev.	Description	Date	Approved	Drawing	Name	Date
				Approved	Howard	02/28/05
				Checked	Lizzy	02/28/05
				Drawn	Tina	02/28/05
				0.0 ± 0.35	0.00 ± 0.20	Angles ± 3'
				UNIT: mm		

**Central Components Manufacturing**  
 440 Lincoln Blvd., Middlesex, New Jersey 08846  
 Phone 732 469-5720 888 288-5152 Fax 732 469-1919

Part No.: **DBS25-XX-XX**

Description: 25 Position D-Sub Backshell