

CED, C type male

Current rating: 2 amps
 Contact material: Brass
 Contact resistance: 30 milliohms max. at 100 milliamps DC
 Housing material: PBT, 30% glass filled, UL94V-0
 Insulation resistance: 1,000 megohms min. at 500VDC
 Withstanding: 1,000VAC for 1 min.
 Operating temperature: -55°C to +105°C

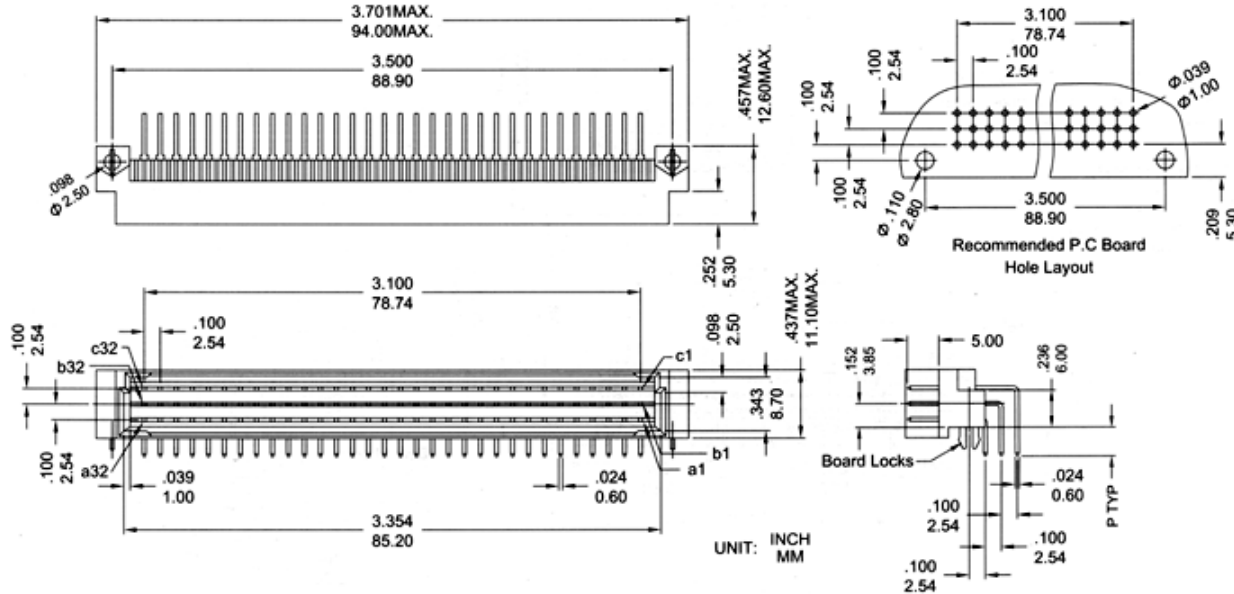

Series	Gender	Mounting	Contacts	Pin Length	Pitch	Loaded Rows	Plating	Type	Options
CED	X	X	XX	XX	XX	XX	XX	CX	XX
Euro DIN 41612 Connector	1=Male 2=Female	A=Straight B=Right Angle	08, 10, 16, 20, 32, 64	A1(M)=2.9mm (male only) A1(F)=4.0mm (female only) A2=2.5mm A1(XX)=Custom Length	B1=.100" (2.54mm) B2=.200" (5.08mm)	1=A (row A loaded) 2=B (row B loaded) 4=A&B (rows A&B loaded)	SG1=30u" SG2=15u" SG3=10u"	C=C Type C2=C2 Type, 1/2 size C3=C3 Type, 1/3 size	[blank]=none PF=Press Fit (straight only) BL=Board Locks

Rev.	Description	Date	Approved	Drawing	Name	Date
				Approved	Howard	09/10/05
				Checked	Lizzy	09/10/05
				Drawn	Tina	09/10/05
				0.0 ± 0.35	0.00 ± 0.20	Angles ± 3'
				UNIT: mm		

Central Components Manufacturing
 440 Lincoln Blvd., Middlesex, New Jersey 08846
 Phone 732 469-5720 888 288-5152 Fax 732 469-1919

Part No.: **CED-X-X-XX-XX-XX-XX-XX-CX-XX**

Description: Euro DIN 41612 Connector, C Type

CED, C2 type male

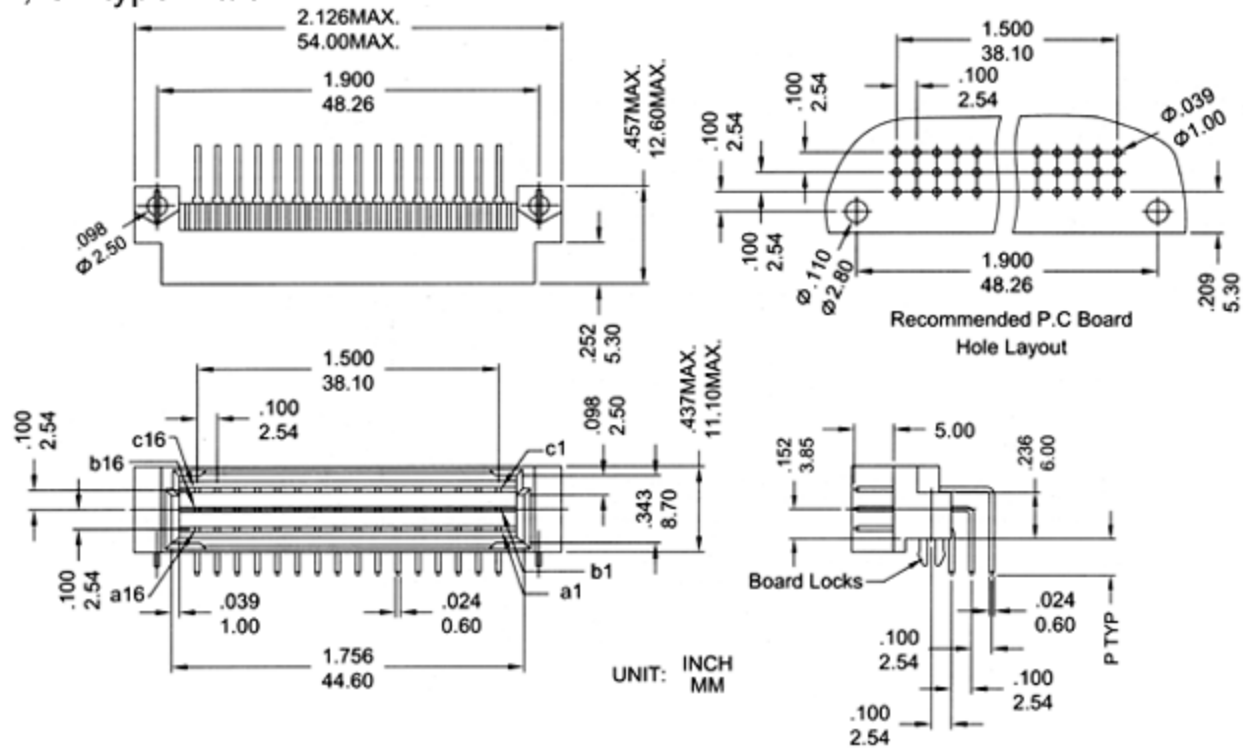

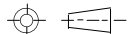
Rev.	Description	Date	Approved	Drawing	Name	Date
				Approved	Howard	09/10/05
				Checked	Lizzy	09/10/05
				Drawn	Tina	09/10/05
				0.0 ± 0.35	0.00 ± 0.20	Angles ± 3'
				 UNIT: mm		

Central Components Manufacturing
 440 Lincoln Blvd., Middlesex, New Jersey 08846
 Phone 732 469-5720 888 288-5152 Fax 732 469-1919

Part No.: **CED-X-X-XX-XX-XX-XX-XX-CX-XX**

Description: Euro DIN 41612 Connector, C Type

CED, C3 type male

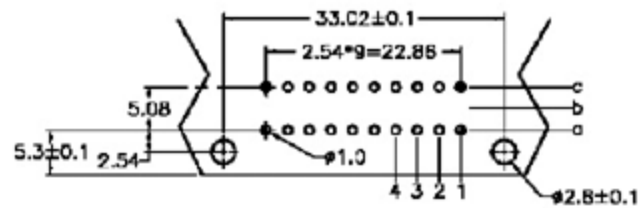
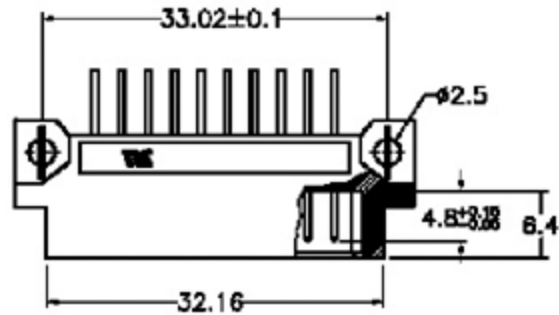
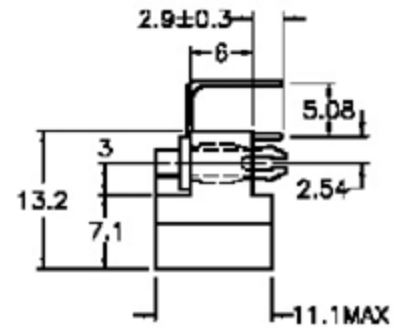
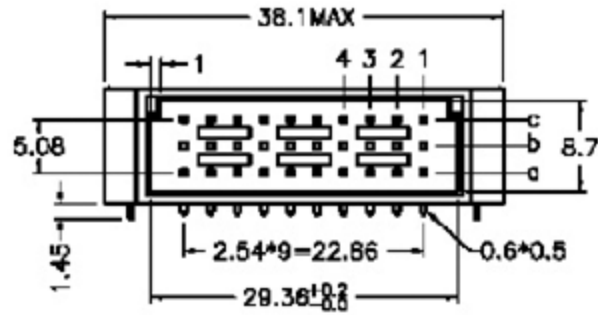

P.C. Board Layout
(Tolerance: ±0.05)

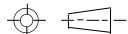
Rev.	Description	Date	Approved	Drawing	Name	Date
				Approved	Howard	09/10/05
				Checked	Lizzy	09/10/05
				Drawn	Tina	09/10/05
				0.0 ± 0.35	0.00 ± 0.20	Angles ± 3'
				 UNIT: mm		

Central Components Manufacturing
 440 Lincoln Blvd., Middlesex, New Jersey 08846
 Phone 732 469-5720 888 288-5152 Fax 732 469-1919

Part No.: CED-X-X-XX-XX-XX-XX-XX-CX-XX

Description: Euro DIN 41612 Connector, C Type

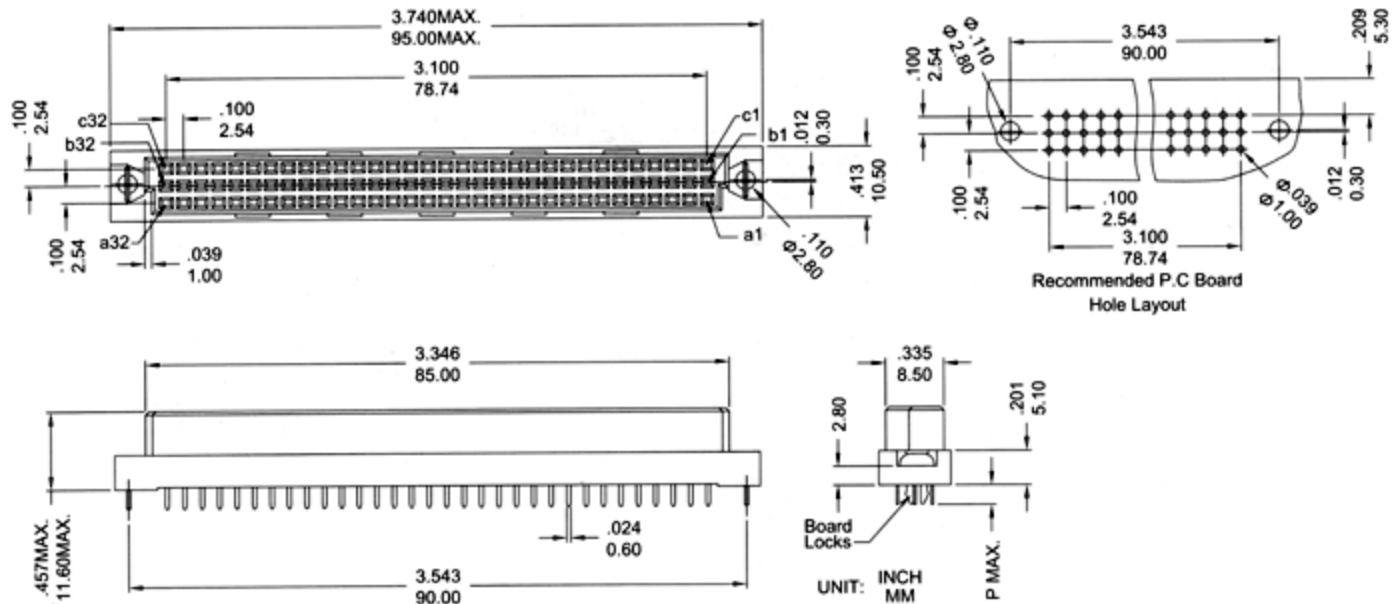

CED, C type female



Rev.	Description	Date	Approved	Drawing	Name	Date
				Approved	Howard	09/10/05
				Checked	Lizzy	09/10/05
				Drawn	Tina	09/10/05
				0.0 ± 0.35	0.00 ± 0.20	Angles ± 3'
				UNIT: mm		

Central Components Manufacturing
 440 Lincoln Blvd., Middlesex, New Jersey 08846
 Phone 732 469-5720 888 288-5152 Fax 732 469-1919

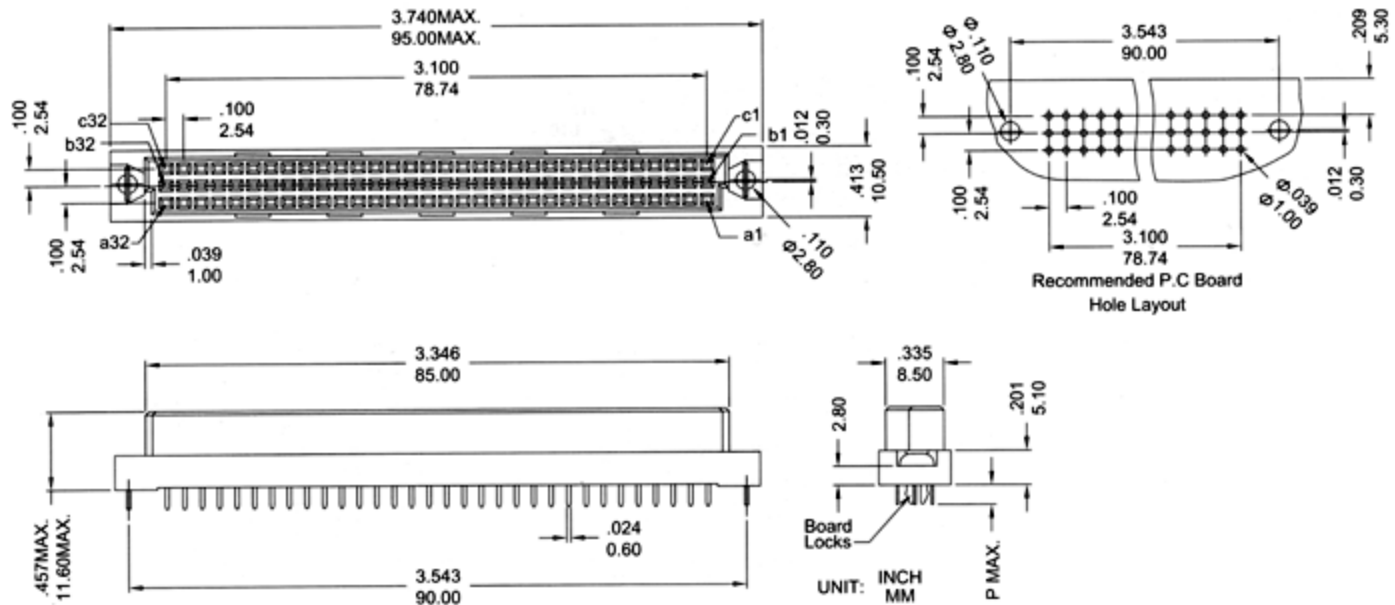
Part No.: **CED-X-X-XX-XX-XX-XX-XX-CX-XX**
 Description: Euro DIN 41612 Connector, C Type

	1	2	3	4	5	6	7	8	9																																										
A	CED, C type female																																																		
B																																																			
C																																																			
D																																																			
E																																																			
F	<table border="1"> <thead> <tr> <th>Rev.</th> <th>Description</th> <th>Date</th> <th>Approved</th> <th>Drawing</th> <th>Name</th> <th>Date</th> </tr> </thead> <tbody> <tr> <td></td> <td></td> <td></td> <td></td> <td>Approved</td> <td>Howard</td> <td>09/10/05</td> </tr> <tr> <td></td> <td></td> <td></td> <td></td> <td>Checked</td> <td>Lizzy</td> <td>09/10/05</td> </tr> <tr> <td></td> <td></td> <td></td> <td></td> <td>Drawn</td> <td>Tina</td> <td>09/10/05</td> </tr> <tr> <td></td> <td></td> <td></td> <td></td> <td>0.0 ± 0.35</td> <td>0.00 ± 0.20</td> <td>Angles ± 3'</td> </tr> <tr> <td></td> <td></td> <td></td> <td></td> <td colspan="3">UNIT: mm</td> </tr> </tbody> </table>									Rev.	Description	Date	Approved	Drawing	Name	Date					Approved	Howard	09/10/05					Checked	Lizzy	09/10/05					Drawn	Tina	09/10/05					0.0 ± 0.35	0.00 ± 0.20	Angles ± 3'					UNIT: mm		
Rev.	Description	Date	Approved	Drawing	Name	Date																																													
				Approved	Howard	09/10/05																																													
				Checked	Lizzy	09/10/05																																													
				Drawn	Tina	09/10/05																																													
				0.0 ± 0.35	0.00 ± 0.20	Angles ± 3'																																													
				UNIT: mm																																															
G	<p>  Central Components Manufacturing 440 Lincoln Blvd., Middlesex, New Jersey 08846 Phone 732 469-5720 888 288-5152 Fax 732 469-1919 </p> <p> Part No.: CED-X-X-XX-XX-XX-XX-XX-CX-XX Description: Euro DIN 41612 Connector, C Type </p>																																																		
	1	2	3	4	5	6	7	8	9																																										

CED, C2 type female

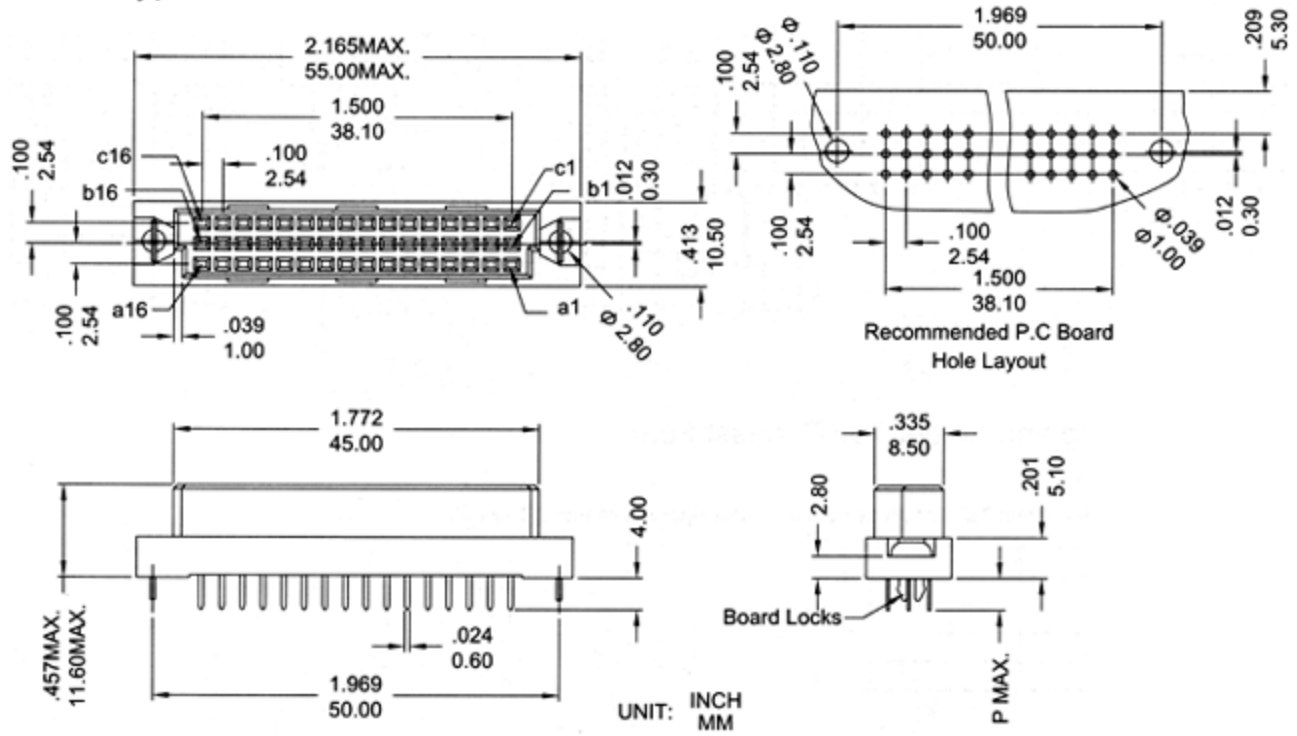

Rev.	Description	Date	Approved	Drawing	Name	Date
				Approved	Howard	09/10/05
				Checked	Lizzy	09/10/05
				Drawn	Tina	09/10/05
				0.0 ± 0.35	0.00 ± 0.20	Angles ± 3'
				UNIT: mm		

Central Components Manufacturing
 440 Lincoln Blvd., Middlesex, New Jersey 08846
 Phone 732 469-5720 888 288-5152 Fax 732 469-1919

Part No.: **CED-X-X-XX-XX-XX-XX-XX-CX-XX**

Description: Euro DIN 41612 Connector, C Type

CED, C3 type female

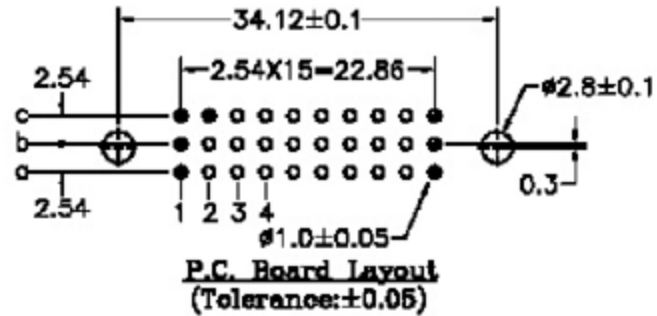
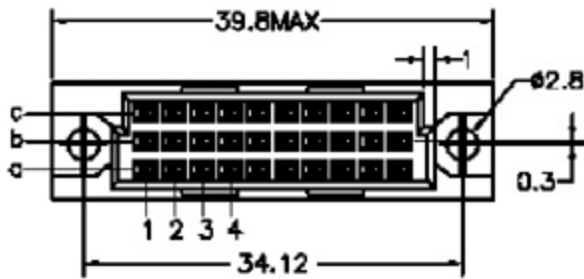
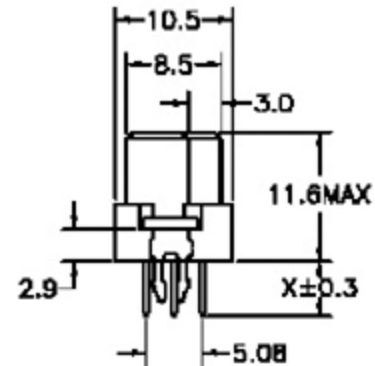
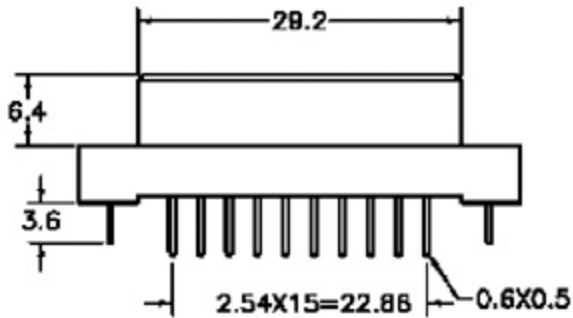

Rev.	Description	Date	Approved	Drawing	Name	Date
				Approved	Howard	09/10/05
				Checked	Lizzy	09/10/05
				Drawn	Tina	09/10/05
				0.0 ± 0.35	0.00 ± 0.20	Angles ± 3'
				UNIT: mm		

Central Components Manufacturing
 440 Lincoln Blvd., Middlesex, New Jersey 08846
 Phone 732 469-5720 888 288-5152 Fax 732 469-1919

Part No.: **CED-X-X-XX-XX-XX-XX-XX-CX-XX**

Description: Euro DIN 41612 Connector, C Type

CED, C type female, pressfit, 3 rows

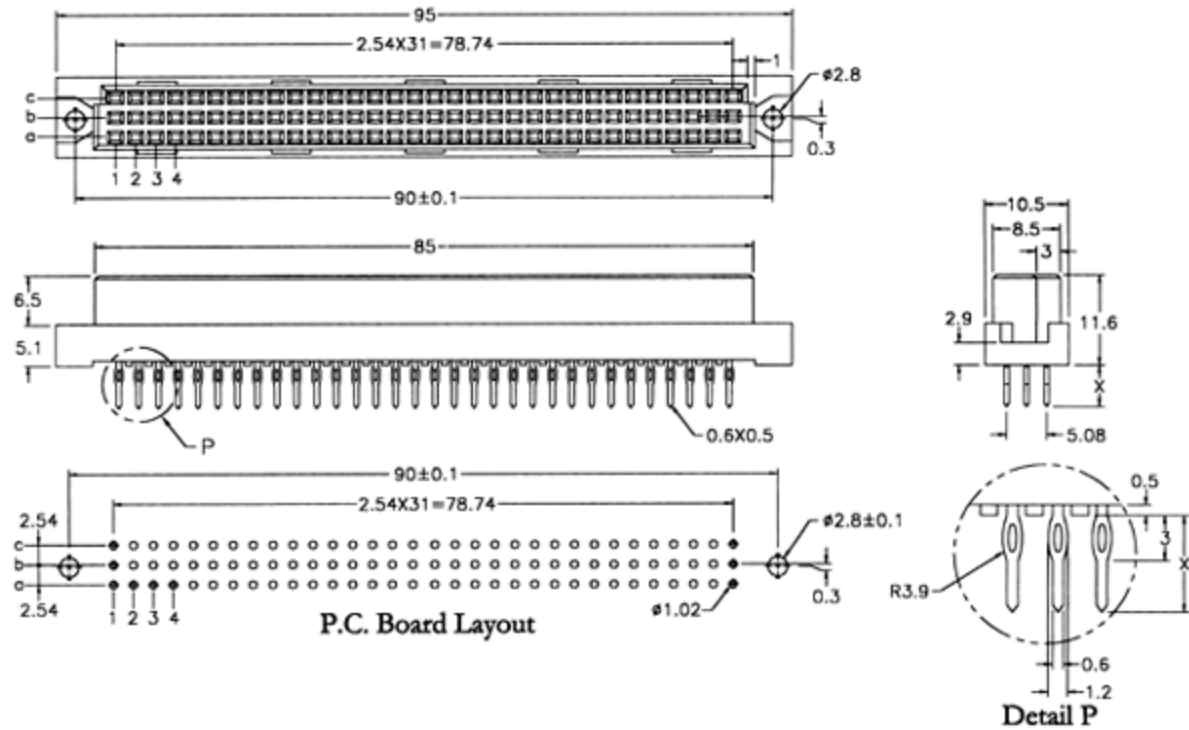

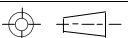
Rev.	Description	Date	Approved	Drawing	Name	Date
				Approved	Howard	09/10/05
				Checked	Lizzy	09/10/05
				Drawn	Tina	09/10/05
				0.0 ± 0.35	0.00 ± 0.20	Angles ± 3'
				 UNIT: mm		

Central Components Manufacturing
 440 Lincoln Blvd., Middlesex, New Jersey 08846
 Phone 732 469-5720 888 288-5152 Fax 732 469-1919

Part No.: **CED-X-X-XX-XX-XX-XX-XX-CX-XX**

Description: Euro DIN 41612 Connector, C Type

CED, C2 type female, pressfit, 3 rows

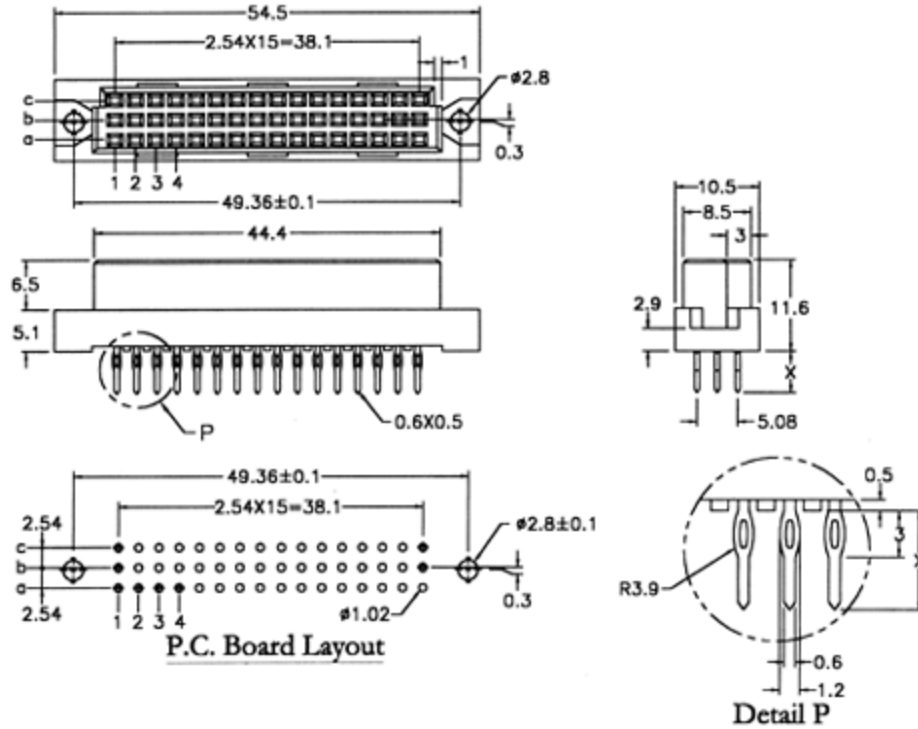

Rev.	Description	Date	Approved	Drawing	Name	Date
				Approved	Howard	09/10/05
				Checked	Lizzy	09/10/05
				Drawn	Tina	09/10/05
				0.0 \pm 0.35	0.00 \pm 0.20	Angles \pm 3'
					UNIT: mm	

Central Components Manufacturing
 440 Lincoln Blvd., Middlesex, New Jersey 08846
 Phone 732 469-5720 888 288-5152 Fax 732 469-1919

Part No.: **CED-X-X-XX-XX-XX-XX-XX-CX-XX**

Description: Euro DIN 41612 Connector, C Type

CED, C3 type female, pressfit, 3 rows

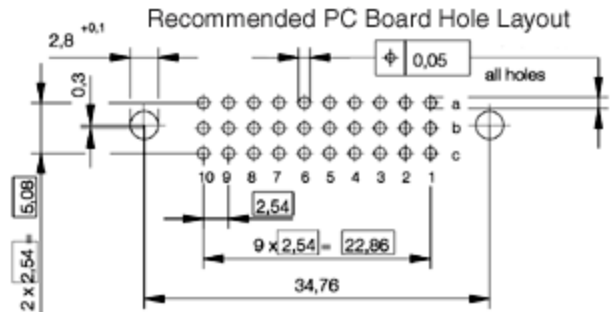
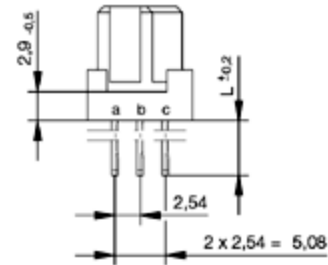
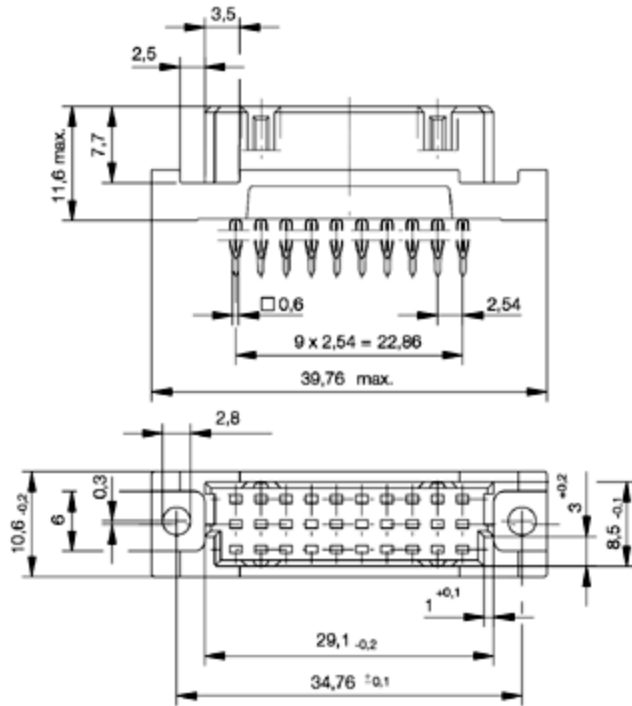

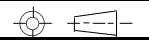
Rev.	Description	Date	Approved	Drawing	Name	Date
				Approved	Howard	09/10/05
				Checked	Lizzy	09/10/05
				Drawn	Tina	09/10/05
				0.0 ± 0.35	0.00 ± 0.20	Angles ± 3'
				 UNIT: mm		

Central Components Manufacturing
 440 Lincoln Blvd., Middlesex, New Jersey 08846
 Phone 732 469-5720 888 288-5152 Fax 732 469-1919

Part No.: **CED-X-X-XX-XX-XX-XX-XX-CX-XX**

Description: Euro DIN 41612 Connector, C Type